

Centrifugal Pumps

Gas handling combi pump in segmental design



HALBERG™ Pumps

UEA 5002 ... 10015

Technical Data

Output:	max. 220 m ³ /h
Differential pressure:	max. 20 bar
Speed:	max. 3600 rpm
Temperature:	-40°C to +80°C
Casing pressure:	PN 40 up to size 8000 PN 25 size 10000
Shaft sealing:	mechanical seal
Flange connections:	DIN EN 1092 PN 25 or PN 40 Option: ASME B 16.5
Sense of rotation:	clockwise, when seen from the drive on the pump
Certification:	ATEX 94/9/EG, Ex II 2 G c T4-T5 GOST



Application

Gas handling centrifugal pumps of the series UEA are used for trouble-free handling of pure or turbid, not aggressive liquids, containing no solids.

The gas handling capability is used to handle mainly liquid gas (LPG) and other hydrocarbon liquidate reshipment points and large gas depots, fire extinguishing plants sprinkling and irrigation plants emptying of fuel trucks filling of high tanks, refueling cars. Centrifugal pumps of the series UEA with special NPSH inducer stage are applied for trouble-free pumping under unfavorable conditions at suction side. A special priming stage is able to absorb eventually existing vapour from the suction side. The capability of the pumps in this series to handle liquids at the boiling point, allows a wide-ranging application when handling:

- LPG
- Hydrocarbon condensates
- Hydrocarbon liquefied gases

Design

Horizontal centrifugal pumps of the segmental type with closed impellers and a suction stage. The suction stage is installed at discharge side. It is arranged in parallel to the last liquid handling stage and operates acc. to the sucking-through principle. The design UEA has an axial inlet with NPSH inducer stage. The axial thrust is compensated by single-impeller relief. The remaining axial thrust is compensated by antifriction bearings of sufficient size. The vertically to the axis divided casings are sealed by O-rings and connected through external casing connection screws.

Construction

Casing pressure:

max. 40 bar up to size 8000 from -40 °C to 120 °C
max. 25 bar up to size 10000 from -40 °C to 120 °C
Pressure stages for higher temperatures acc. DIN EN 764-1

Please note:

Technical rules and safety rules.
Casing pressure = zero delivery head + pos. suction pressure

Position of the branches:

Suction flange axially and discharge flange radially upwards.

Flanges:

At suction and discharge side the flanges correspond to DIN EN 1092 PN 25 and PN 40. Flange design with groove to DIN EN 1092 or bored to ASME B 16.5 possible.

Hydraulics:

Centrifugal hydraulic with special NPSH-impeller and gas priming stage.

Bearings:

At suction side a liquid surrounded sleeve bearing, at discharge side grease lubricated inclined ball bearings as per DIN 628. The designation of this construction: A
First grease filling for antifriction bearing is made in the factory.

Sense of rotation:

Clockwise when looking at the pump from the drive end.

Shaft sealing:

The shaft can be sealed either by single mechanical seal or by double mechanical seal.

Special for liquid gas:

- Designation DNE: Flowserve EUROPAC 610 (balanced, internal flushed) standard single mechanical seal with throttle bush for leakage control.
Temperature range: from -40 °C to 120 °C
max. 40 bar
- Designation RBG: Flowserve EUROPAC 610/610 (balanced, internal or external flushed), acc. API 682 Plan 52 in tandem arrangement
Temperature range: from -25 °C to 120 °C
max. 40 bar
- Designation KEY: Burgmann Cartex DE (balanced, external flushed) double mechanical seal in back to back arrangement acc. API 682 Plan 53 (optional Plan 52 for tandem arrangement)
Temperature range: from -40 °C to 120 °C
max. 25 bar

Sectional drawing and nomenclatures

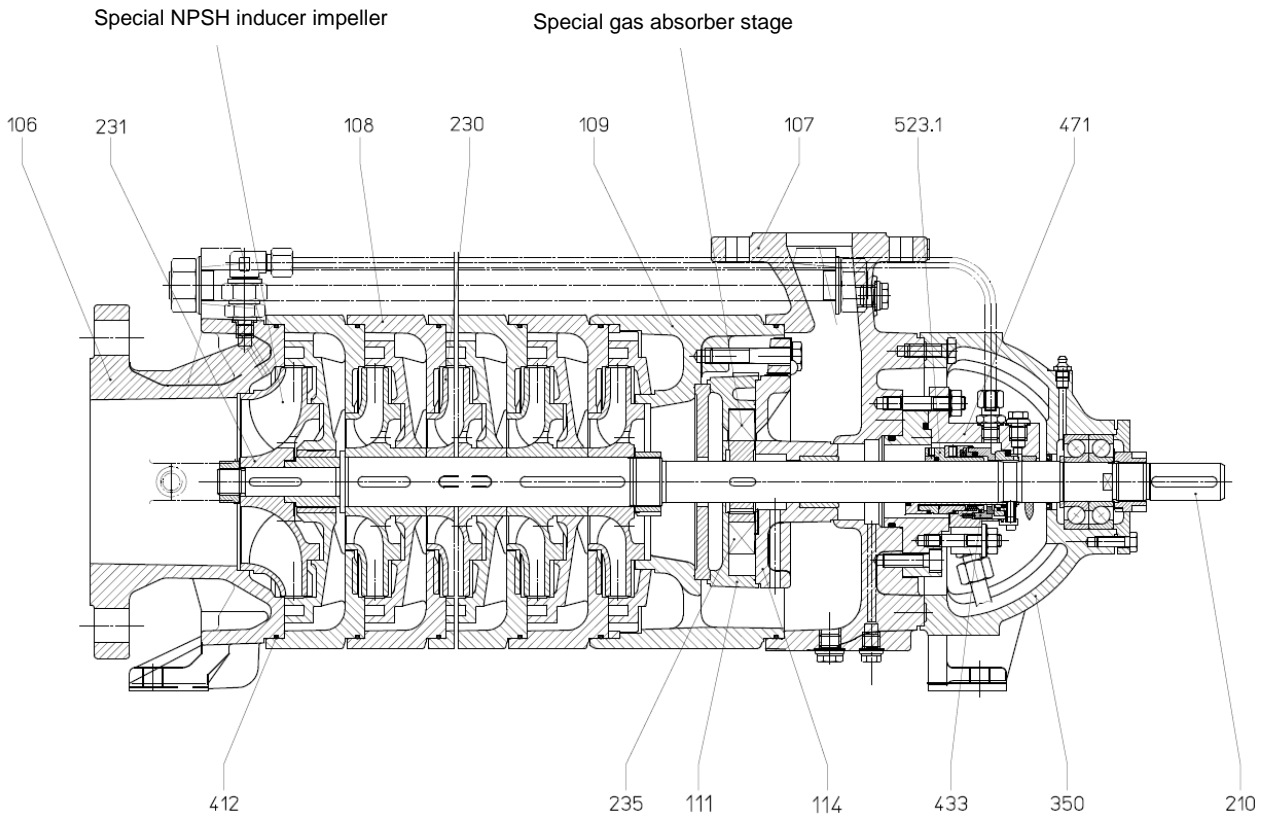

UEA with balanced single mechanical seal DNE with throttle bush

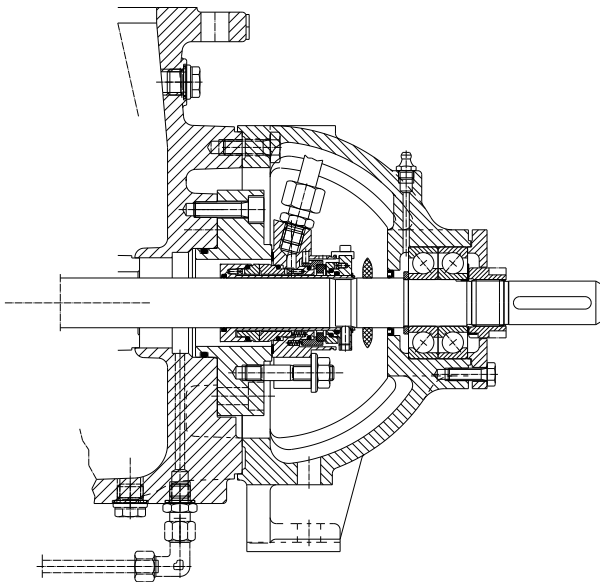

UEA with XEY, Cartex (PN25) double mechanicals seal

Arrangement:
 'Back to back' API 682 plan 53 or optional
 'Tandem' API 682 plan 52

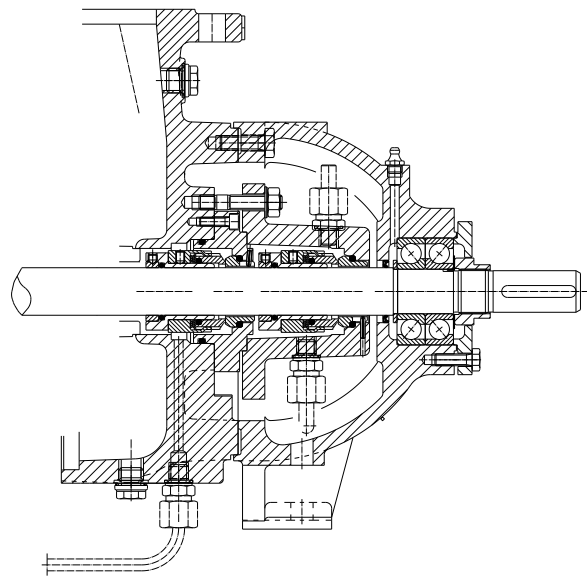

UEA with RBG, (PN40) double mechanicals seal

Arrangement:
 'Tandem' API 682 plan 52

Material design:

Item	COMPONENTS		MATERIAL DESIGN	
			1A	2C
106	Suction casing		EN-JS1025 - EN 1563 (0.7043)	1.0619 - EN 10213 (GS-C25)
107	Discharge casing			
108	Stage casing			
109	Stage shell			
111	Suction stage (internal)		EN-JL1040 - EN 1561 (0.6025)	
114	Side cannel casing			
210	Shaft		1.4122+QT - EN 10088-3	
230	Impeller (internal)		EN-JL2030 - EN 1561 (0.6022)	
231	NPSH impeller		EN-JL2030 - EN 1561 (0.6022)	EN-JL2030 - EN 1561 (0.6022)
235	Vane wheel impeller		CC483K-GS - EN 1982 (2.1052.01)	
350	Bearing casing		EN-JL1040 - EN 1561 (0.6025)	
412	O-ring		NBR 70 (standard)	NBR 70 (standard)
433	Shaft sealing	DNE	Chrome steal/carbon, NBR (SANGG)	
		RBG	Chrome steal/carbon, NBR (2 x SANGG)	
		XEY	Carbon graphit / SiC, NBR (AQ1PMG-AQ1PMG)	
523	Shaft sleeve at mechanical seal		1.4571 - EN 10088-3	

Casing seal:

The casing is sealed by O-rings of NBR.

Drive / Speed:

By commercial electric motors, construction type IM B3.

Observe the following max. speed dependent on the number of stages:

series & size	max. speed	series & size	max. speed	series & size	max. speed	series & size	max. speed
UEA 5002 - 03	3600	UEA 5002 - 10	3000	UEA 5002 - 10	1800	UEA 5002 - 10	1500
UEA 6502 - 05		UEA 6502 - 07		UEA 6502 - 07		UEA 6502 - 07	
		UEA 8002 - 03		UEA 8002 - 09		UEA 8002 - 13	
				UEA 10002 - 08		UEA 10002 - 15	

Technical documentation for other programmes are available on request.

Data regarding size

series + size	speed	hydraulics + bearings	shaft sealing	material design	flange design	
UEA		A• hydraulic A with NPSH impeller 1 8002 - 8003 10002 - 10015	Specially for liquefied gas	1A -20°C to 80°C	1 flanges acc. DIN	
		M• hydraulic A with NPSH impeller 1 5002 - 5010 6502 - 6507	DNE Flowserve, balanced standard single mechanical, PN 40, t = -40 °C to 120 °C , seal with internal flushing, throttle bush with option to monitor leakage	cast iron with nodular cast iron EN-JS1025 - EN 1563 (0.7043 / (GGG 40.3)	F flanges acc. ASME (ANSI)	
		•A two grease lubricated single row inclined ball bearings and one liquid surrounded sleeve bearing	RBG Flowserve balanced double mechanical seal (tandem). PN 40, t = -25 °C to 120 °C, seal with internal and external flushing (API 682 plan 52), option to monitor leakage	O-ring: NBR 70 (standard)		
			KEY Burgmann Cartex balanced double mechanical seal in back to back or tandem arrangement Depending of external supplier seal with internal and external flushing with pumping rings PN 25, t = -40 °C to 120 °C, seal, (API 682 plan 52 and 53), option to monitor leakage	2C -40°C to 80°C cast steel 1.0619 - EN 10213 / (GS - C25) O-ring: NBR 70 (special -40°C)		
UEA	5002 - 5010	1450	MA	DNE	1A	1
	6502 - 6507					
	8002 - 8013					
	10002 - 10015	2900	AA	RBG	2C	F
	5002 - 5010					
	6502 - 6507					
8002 - 8003		MA	KEY			
		AA				

design	code	Motor selection table for EEXd.....					
		motor n = 2900 rpm			motor n = 1450 rpm		
		kW	size	code	kW	size	Code
pump with free shaft end	01	15	160 M	TA	3	100 L	LB
		18.5	160 L	UA	4	112 M	MB
		22	180 M	VA	5.5	132 S	NB
pump with coupling, ready drilled at motor side and contact safety device for shaft coupling	41	30	200 L	XA	7.5	132 M	PB
		37	200 L	YA	11	160 M	SB
		45	225 M	AA	15	160 L	UB
as above, but pump and contact safety device for the shaft coupling mounted on base plate, incl. shims for pump or motor and 1 set of rag bolts	53	55	250 M	BA	18.5	180 M	VB
		75	280 S	CA	22	180 L	WB
		90	280 M	DA	30	200 L	XB
		110	315 S	EA	37	225 S	ZB
as above, but with motor e.g. 45 kW 3-phase AC motor (50 Hz, 400 V), at 1450 rpm	e.g. AB	132	315 M	FA	45	225 M	AB
		160	315 M	GA	55	250 M	BB
					75	280 S	CB
					90	280 M	DB
					110	315 S	EB
						FB	

Example for ordering:

The size UEA- 8007 AA DNE 1A 1 with coupling, ready drilled at motor side and contact safety device for the shaft coupling has the complete order number:

UEA. 8007 AA DNE 1A 1 41

The size UEA- 8007 AA DNE 1A 1 as complete unit with 45 kW 3-phase AC motor, 1450 rpm, has the complete order number:

UEA. 8007 AA DNE 1A 1 AB

On delivery the point (•) in the fourth place of the type design will be replaced by a letter.

In case of ordering the designs 41 and 53 please indicate always the requested motor, in order that the coupling can be ready drilled at motor side, the suitable base plate can be selected and the appropriate shims can be attached.

Characteristic curves

$\rho = 0,56 \text{ kg/dm}^3$

$n = 2900 \text{ rpm}$

UEA 5002 - 5005

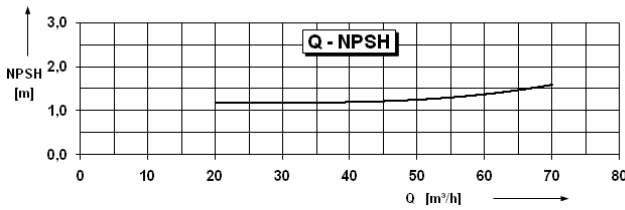
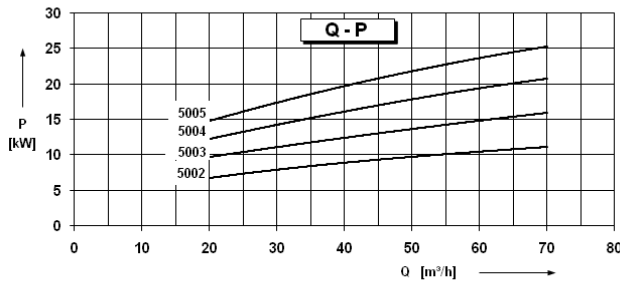
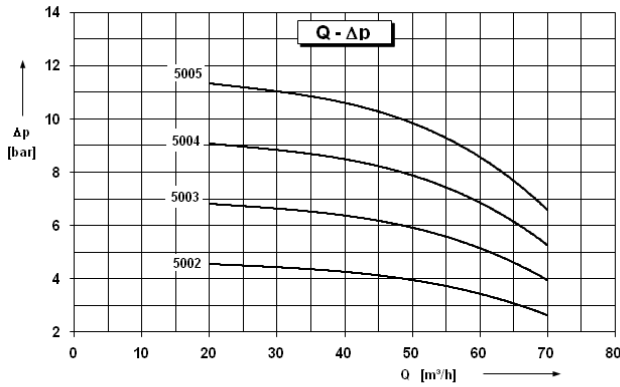

UEA 5006 - 5010

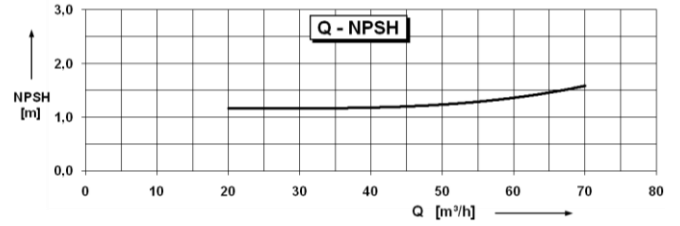
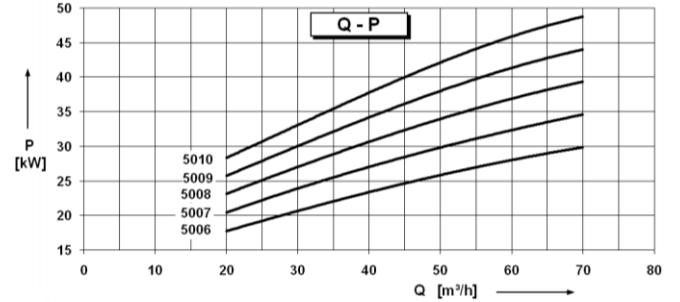
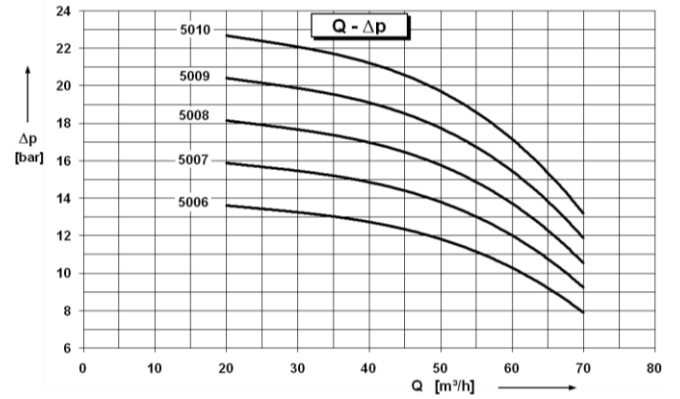

UEA 6502 - 6507

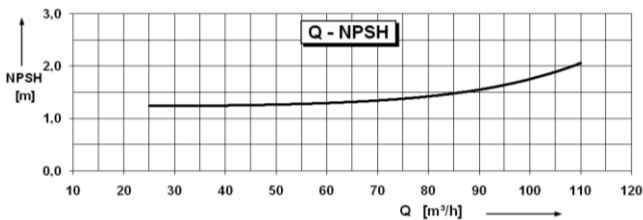
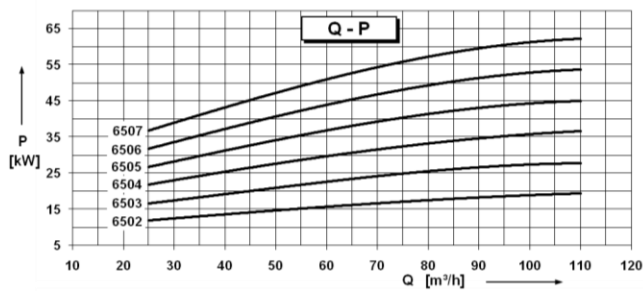
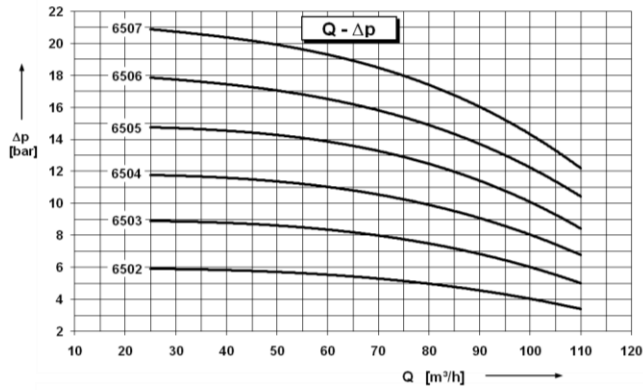

UEA 8002 - 8003

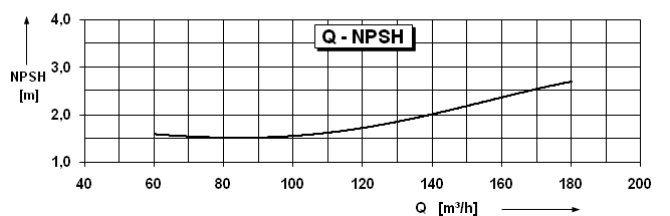
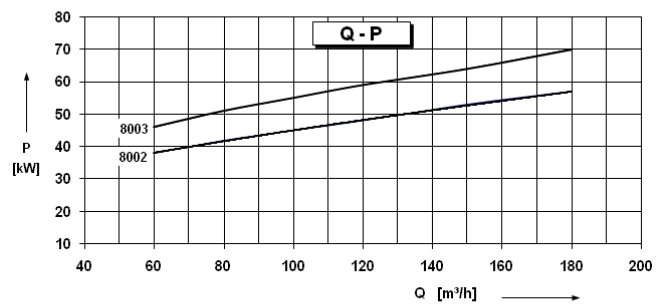
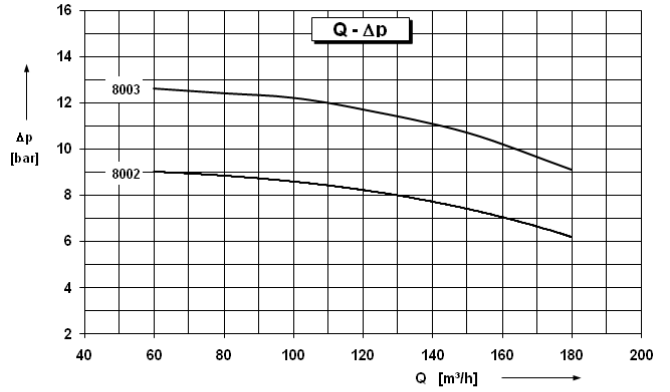

Characteristic curves

$\rho = 0,56 \text{ kg/dm}^3$

$n = 1450 \text{ rpm}$

UEA 8002 - 8005

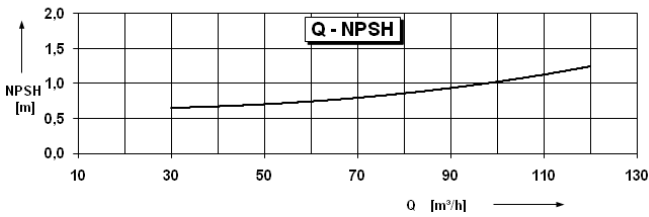
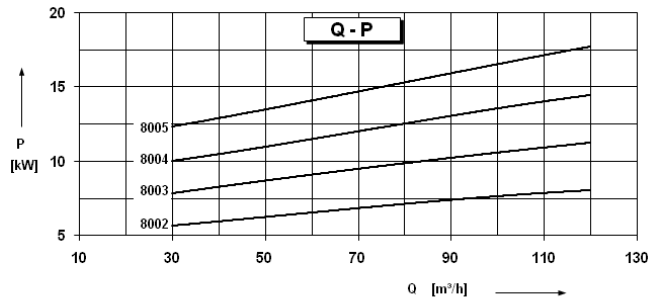
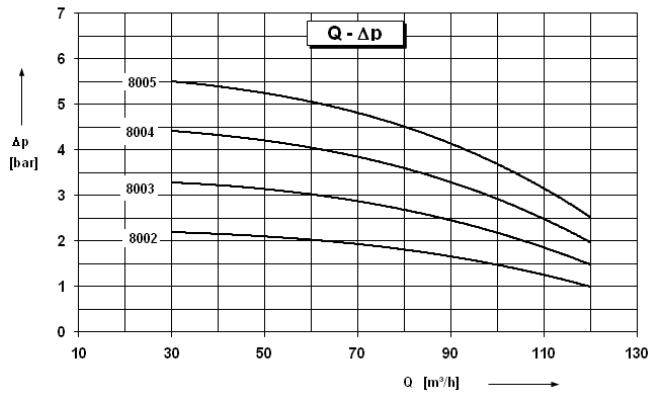

UEA 8006 - 8008

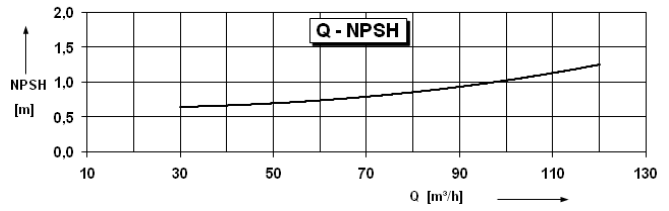
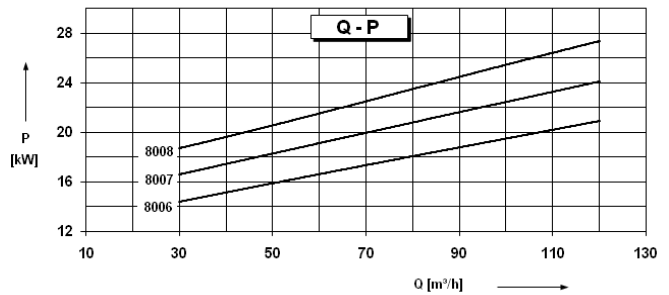
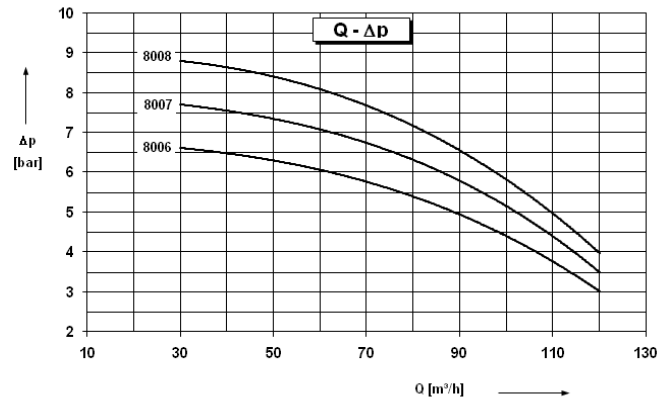

UEA 8009 - 8011

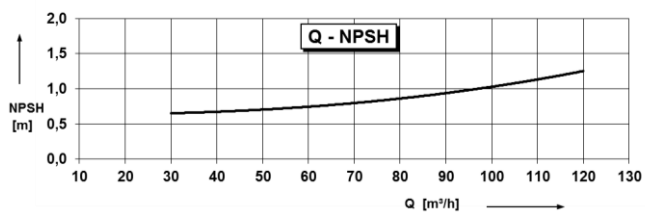
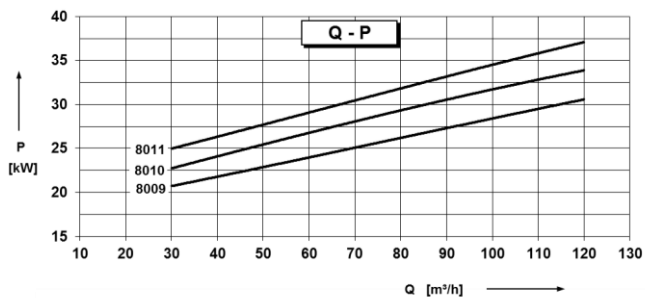
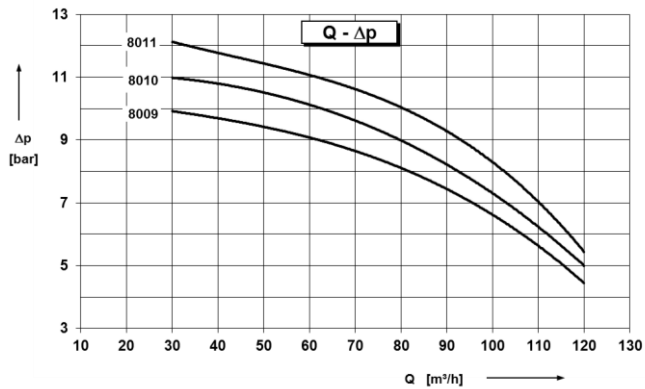

UEA 8012 - 8013

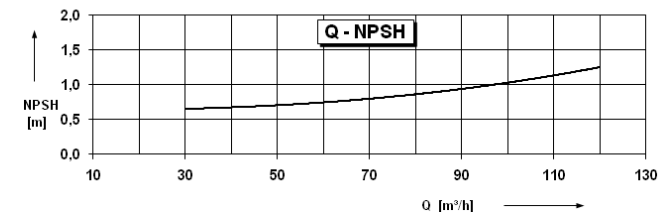
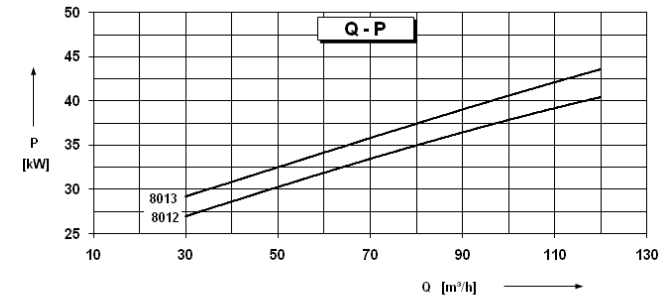
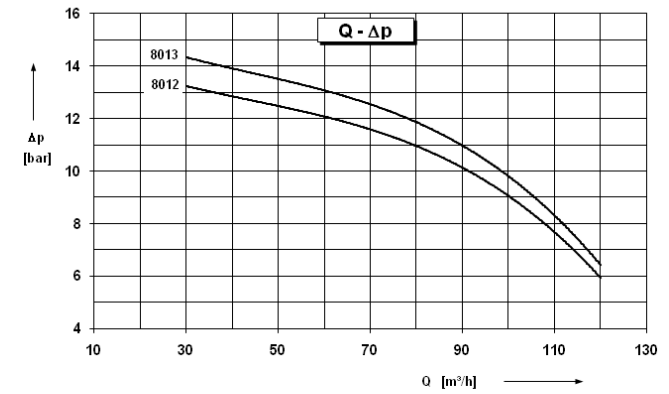

Characteristic curves

$\rho = 0,56 \text{ kg/dm}^3$

$n = 1450 \text{ rpm}$

UEA 10002-10004

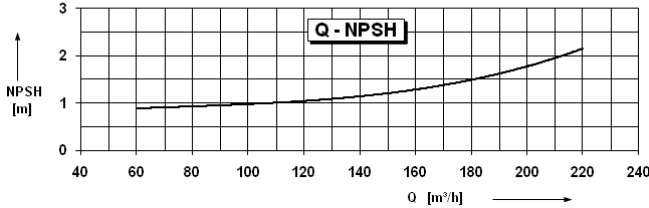
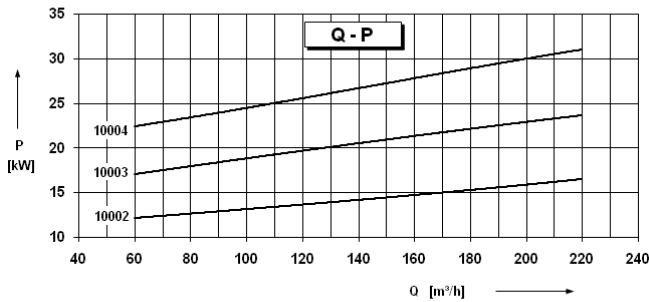
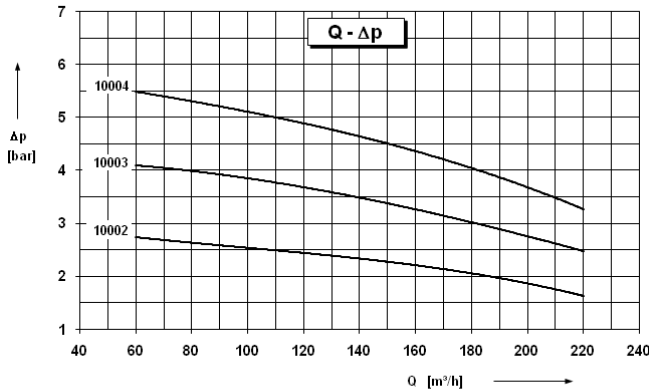

UEA 10005-10007

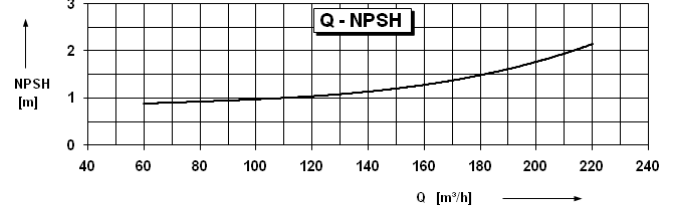
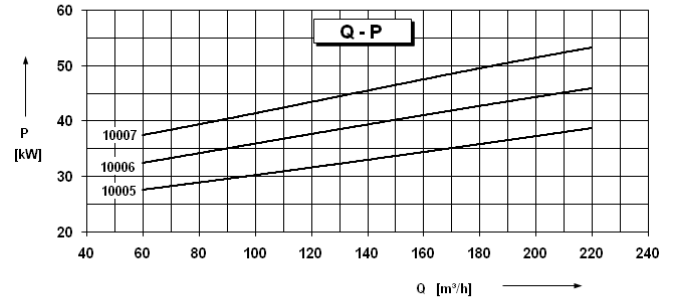
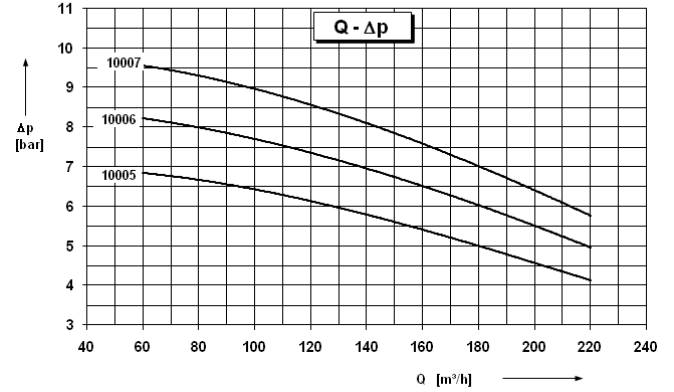

UEA 10008-10010

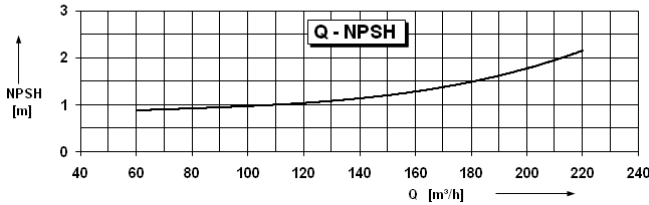
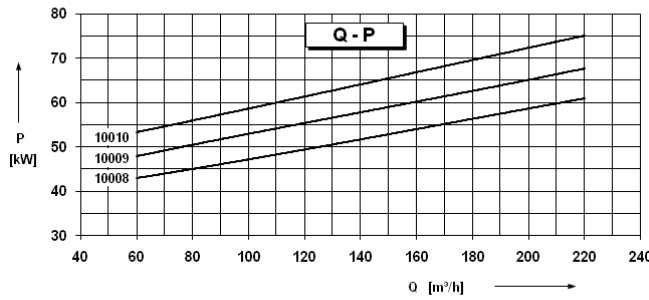
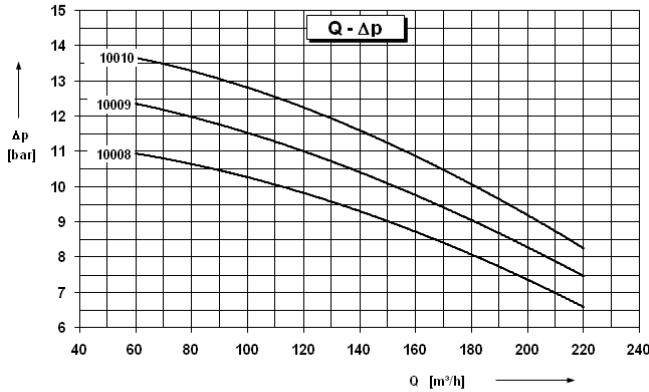

UEA 10011-10015

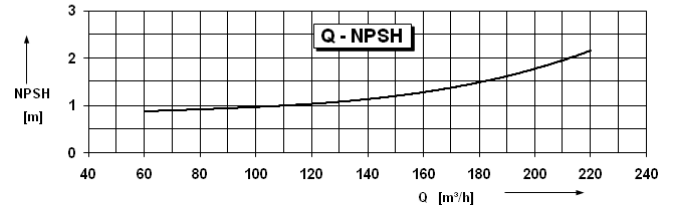
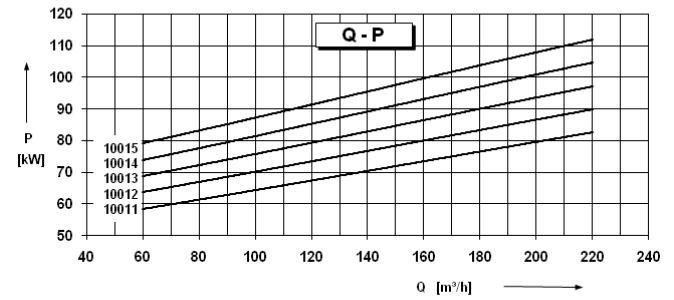
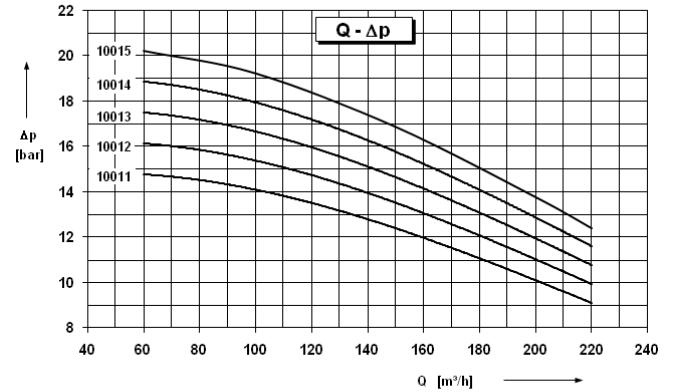

Dimension table

Normal casing pressure: PN 40 for UEA 50 – 80, PN 25 for UEA 100

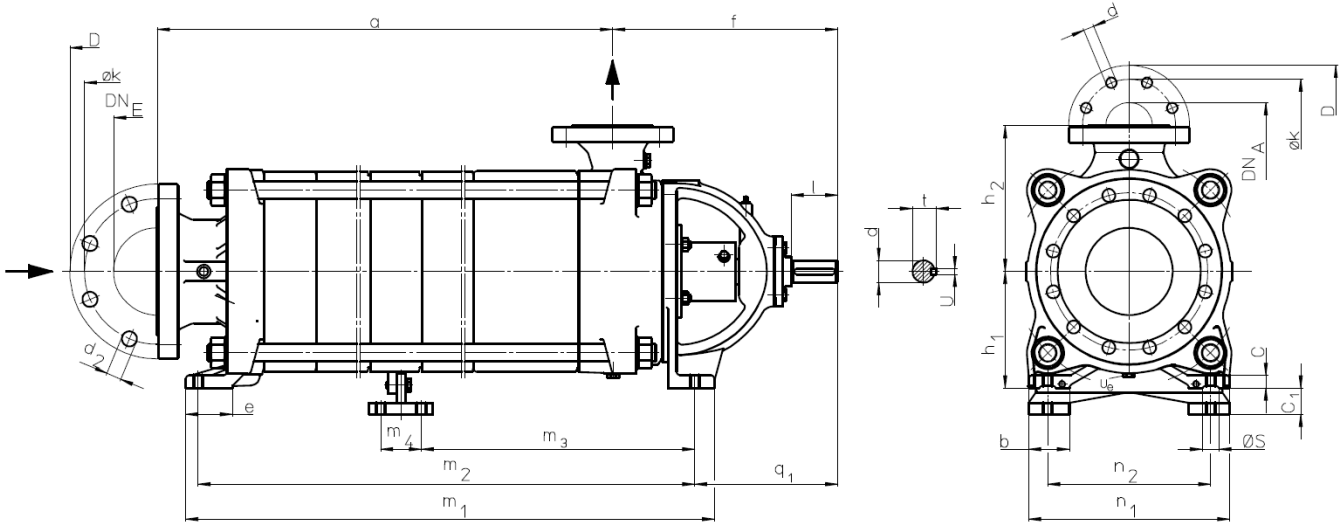

u_e = connection for drain G3/8, for UEA 10 000 G1/2, u_m = connection for pressure gauge G3/8

Dimensions in mm

size	DN _A	DN _E	b	c	e	f	h ₁	h ₂	n ₁	n ₂	s	q ₁	dk ₆	l	t	u
5000	50	125	50	18	60	310*	160	190	266	216	15	187*	28	60	31	8
6500	65	125	60	18	70	358	180	215	314	254	15	233	32	80	35	10
8000	80	150	70	22	80	387	200	250	345	280	15	246	38	80	41	10
10000	100	200	80	25	100	442	250	300	400	318	18	276	42	110	45	12

* UEA 05009 and 05010, f = 357,5, q₁ = 234,5

size	a	m ₁	m ₂	m ₃	weight kg
5002	371	484	446	-	105
5003	433	546	508	-	119
5004	495	608	570	-	133
5005	557	670	632	-	147
5006	619	732	694	-	161
5007	681	794	756	-	175
5008	743	856	818	-	189
5009	867	980	942	525	217
5010	929	1042	1004	587	231
6502	444	550	510	-	139
6503	519	625	585	-	160
6504	594	700	660	-	181
6505	669	775	735	-	202
6506	744	850	810	-	223
6507	819	925	885	-	244
8002	512	638	583	-	191
8003	602	728	673	-	221
8004	692	818	763	-	251
8005	782	908	853	-	281
8006	872	998	943	-	311
8007	962	1088	1033	-	341
8008	1052	1178	1123	-	371
8009	1142	1268	1213	-	401
8010	1322	1448	1393	739.5	455
8011	1412	1538	1483	739.5	485
8012	1502	1628	1573	829.5	515
8013	1592	1718	1663	919.5	545

m₄: 70mm (only for size 80)

size	a	m ₁	m ₂	m ₃	weight kg
10002	581	728	650	-	289
10003	691	838	760	-	337
10004	801	948	870	-	385
10005	911	1058	980	-	433
10006	1021	1168	1090	-	481
10007	1131	1278	1200	-	529
10008	1241	1388	1310	-	577
10009	1351	1498	1420	-	625
10010	1571	1718	1640	889	710
10011	1681	1828	1750	889	758
10012	1791	1938	1860	999	806
10013	1901	2048	1970	1109	854
10014	2011	2158	2080	999	902
10015	2121	2268	2190	1219	950

Flange connections to DIN EN 1092						
PN 40						
DN _{A,E}	50	65	80	100	125	150
D	165	185	200	235	270	300
k	125	145	160	190	220	250
d ₂ x quan.	18 x 4	18 x 8	18 x 8	22 x 8	26 x 8	26 x 8
PN 25						
DN _{A,E}	100	200				
D	235	360				
k	190	310				
d ₂ x quan.	22 x 8	26 x 12				

Dimension table

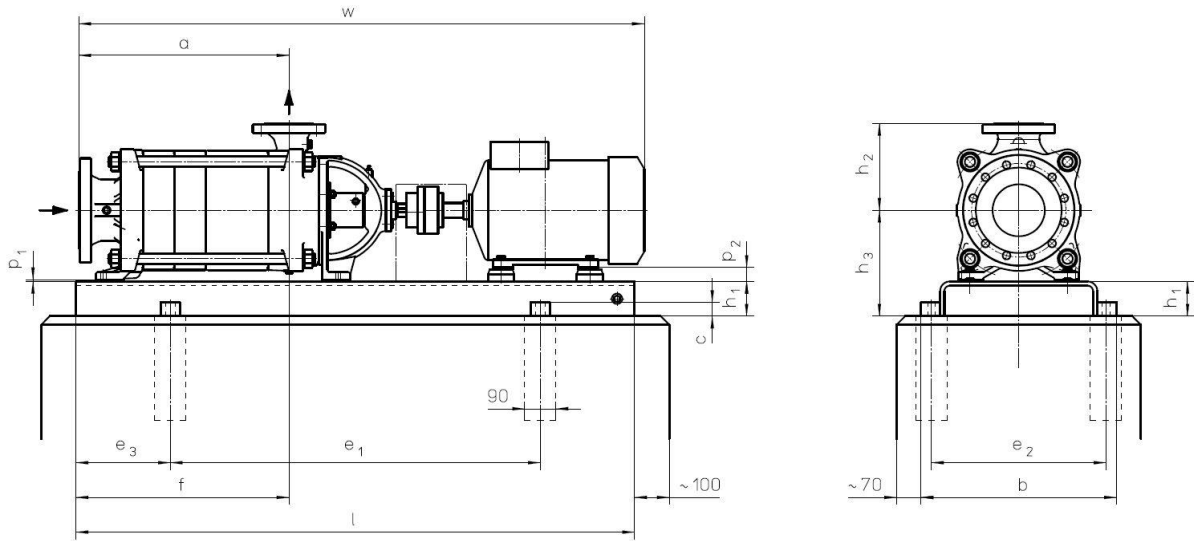

Dimensions in mm

Pump size	motor		a	b	c	e ₁	e ₂	e ₃	f	h ₁	h ₂	h ₃	l	p ₁	p ₂	w	Rag bolt	weight kg		
	kW	size																		
5002	15	160M	371	540	30	840	490	215	381	80	190	245	1270	5	5	1275	M20x250	289		
5003	18.5	160L	433	610	35	940	550	240	443	100	190	265	1420	5	5	1337	M24x400	413		
	22	180M										295		25		1467		426		
5004	18.5	160L	495	610	35	940	550	240	505	100	190	265	1420	5	5	1439	M24x400	426		
	22	180M										295		25		1529		440		
	30	200L										305		1600		45		5	1584	M24x400
5005	30	200L	557	560	40	1060	500	270	567	100	190	305	1600	45	5	1646	M24x400	516		
	45	225M		660	35		600	280				330	1620	70		1676		638		
5006	22	180M	619	560	40	1060	500	270	629	100	190	285	1600	25	5	1653	M24x400	453		
	30	200L										305		1600		45		5	1708	530
	37	200L										305		1600		45		5	1708	550
5007	45	225M	681	560	40	1200	500	300	691	100	190	305	1800	45	5	1770	M24x400	555		
	37	200L										330	1820	70		1800		575		
5008	45	225M	743	730	40	1200	670	310	753	100	190	330	1820	70	5	1862	M24x400	711		
	55	250M														1862		711		
5009	55	250M	867	740	40	2x700	690	300	877	100	190	355	2000	95	5	2159	M24x400	843		
6502	22	180M	444	610	35	940	550	240	454	100	215	285	1420	5	5	1526	M24x400	437		
6503	30	200L	519	660	35	1060	600	280	529	100	215	305	1620	25	5	1656	M24x400	554		
	30	200L																	660	35
6504	45	225M	594	740	40	1200	690	300	604	100	215	305	1620	25	5	1731	M24x400	575		
	45	225M										330	1600	50		1761		686		
	55	250M										355	1800	75		1886		792		
6505	45	225M	669	740	40	1200	690	300	679	100	215	330	1800	50	5	1836	M24x400	749		
	55	250M										355	1800	75		1961		813		
6506	55	250M	744	740	40	2x700	690	300	754	100	215	355	2000	75	5	2036	M24x400	856		
6507	75	280S	819	740	40	2x700	690	300	829	100	215	390	2000	110	10	2186	M24x400	1084		
8002	15	160L	512	610	35	940	550	240	512	100	250	305	1420	5	45	1532	M24x400	421		
	75	280S		740	40	1200	690	300	522			385	1800	85	5	1911		1013		
8003	15	160L	602	560	40	1060	500	270	612	100	250	305	1600	5	45	1622	M24x400	442		
	75	280S		740	40	2x700	690	300				385	2000	85	5	1998		1075		
	90	280M		740	40	2x700	690	300				385	2000	85	5	1998		1105		
8004	15.5	180M	692	560	40	1200	500	300	702	100	250	305	1800	5	25	1802	M24x400	554		
	22	180L														1802		579		
8005	22	180L	782	560	40	1200	500	300	792	100	250	305	1800	5	25	1892	M24x400	609		
8006	30	200L	872	740	40	2x700	690	300	882	100	250	305	2000	5	5	2037	M24x400	782		
8007	30	200L	962	740	40	2x700	690	300	972	100	250	305	2000	5	5	2127	M24x400	812		
8008	37	225S	1052	740	40	2x750	690	370	1062	100	250	330	2240	30	5	2282	M24x400	964		
8009	37	225S	1142	740	40	2x750	690	370	1152	100	250	330	2240	30	5	2372	M24x400	964		
	45	225M														2465		994		
	55	250M														2465		1174		
8010	45	225M	1322	740	40	2x830	690	420	1242	100	250	355	2500	55	5	2555	M24x400	1264		
8011	45	225M	1412	740	40	2x830	690	420	1332	100	250	355	2500	55	5	2645	M24x400	1294		

Dimension table

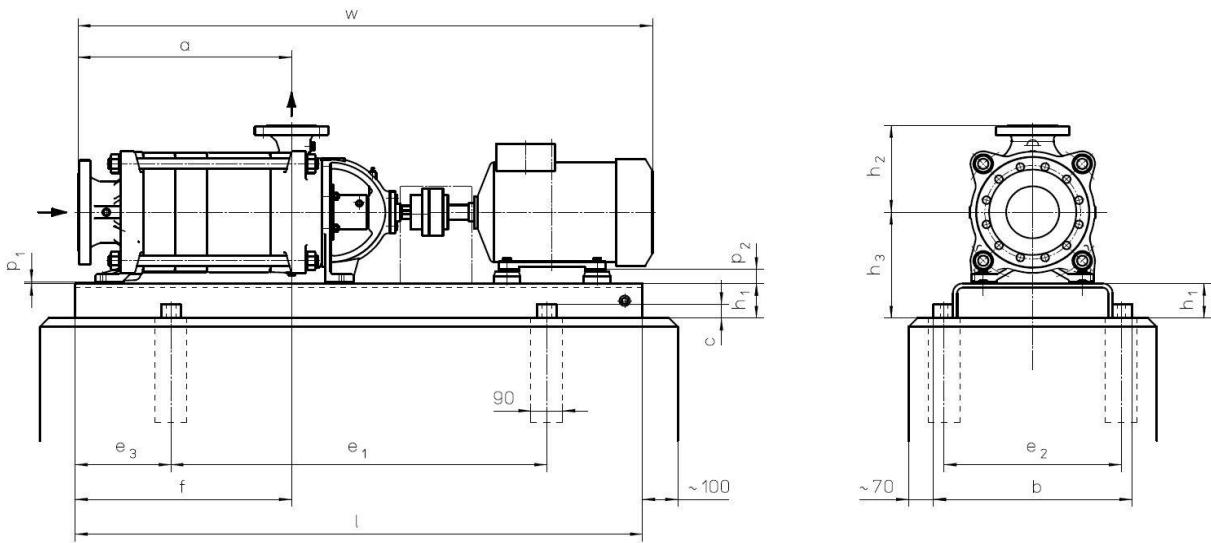

Dimensions in mm

Pump size	motor		a	b	c	e ₁	e ₂	e ₃	f	h ₁	h ₂	h ₃	l	p ₁	p ₂	w	rag bolt	weight kg
	kW	size																
10002	22	180M	581	560	40	1200	500	300	591	100	300	355	1800	5	75	1747	M24x400	608
10003	30	200L	691	560	40	1200	500	300	701	100	300	355	1800	5	55	1906	M24x400	709
	45	225M		740														2x700
10004	37	225S	801	740	40	2x700	690	300	811	100	300	355	2000	5	30	2082	M24x400	939
	45	225M																969
10005	45	225M	911	740	40	2x700	690	350	921	100	300	355	2100	5	30	2192	M24x400	1003
10006	45	225M	1021	740	40	2x750	690	370	1031	100	300	355	2240	5	30	2302	M24x400	1065
	55	250M													5	2397		1206
	75	280S													5	2472		1408
10007	55	250M	1131	740	40	2x830	690	420	1141	100	300	355	2500	5	5	2507	M24x400	1329
	75	280S										35		5	2582	1531		
10008	75	280S	1241	740	40	2x830	690	420	1251	100	300	385	2500	35	5	2692	M24x400	1529
	90	280M																1579

Other designs on request.

For additional details about the pump and the pump set please use the catalogue „Accessories UEA“.

Any changes in the interest of the technical development are reserved.

